

Especificaciones

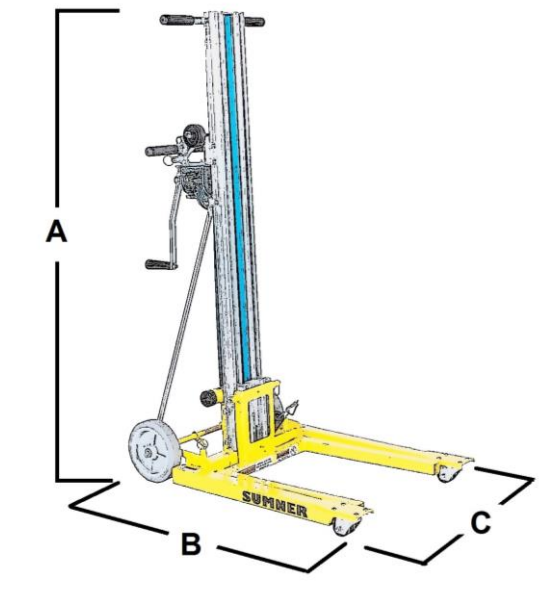

Dimensiones



	Altura máxima horquilla bajada	6,70 m
	Altura máxima horquilla girada	7,30 m
A	Altura recogida	2,13 m
	Largo recogido	0,80 m
	Ancho recogido	0,86 m
B	Largo operativo	1,84 m
C	Ancho desplegada	0,80 m
D	Ancho con estabilizadores	1,88 m
	Motor	Manual
	Tara	166 kg
	Capacidad de carga	300 kg